

Primární / Sekundární vzduch
Primärluft / Sekundärluft
Primary / Secondary air

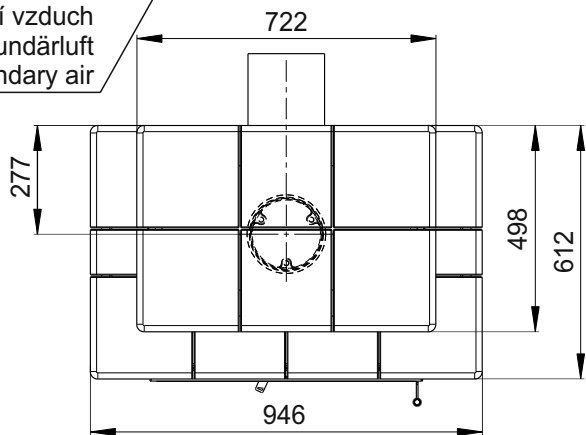

Centrální přívod vzduchu
Zentralluftzufuhr
Central air inlet

Rozměry v mm
Maße in mm
Dimensions in mm

Kachlová kamna Kachelöfen Tiled Stoves	Typ Type Typ	BARACCA 9	
Hmotnost Gewicht Weight	370 kg	Rozměry topeniště (výška x šířka x hloubka) Maße Feuerraum (höhe x breite x tiefe) Combustion Chamber Dimensions (height x width x depth)	330 x 520 x 300 (mm)
		Hein & spol. - keramické závody, spol. s r. o. Odry - Tošovice	