

Primární / Sekundární vzduch  
Primärluft / Sekundärluft  
Primary / Secondary air

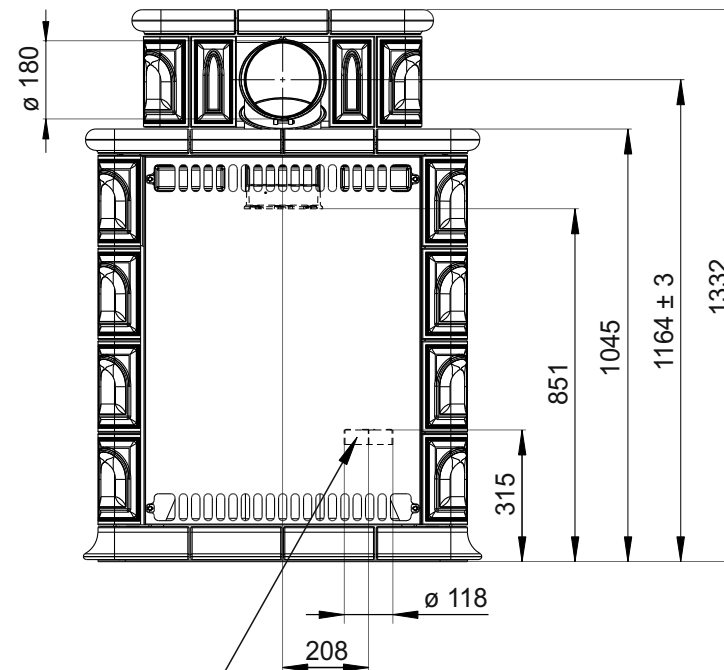

Centrální přívod vzduchu  
Zentralluftzufuhr  
Central air inlet

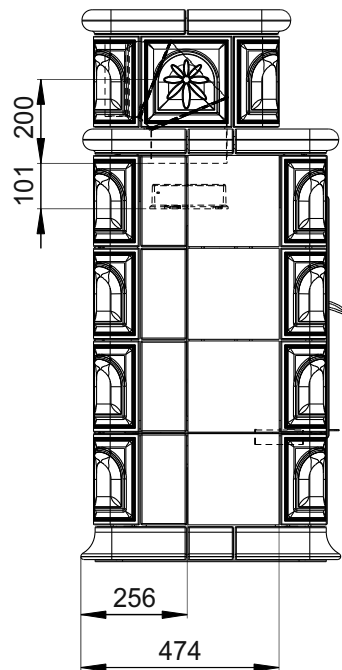
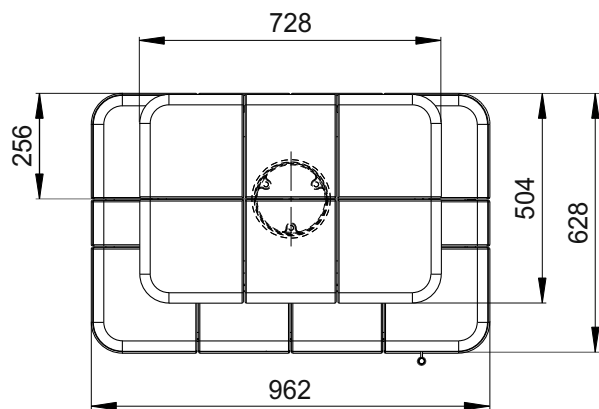

Rozměry v mm  
Maße in mm  
Dimensions in mm

Kachlová kamna Kachelöfen Tiled Stoves	Typ Type Typ	<b>BARACCA 3</b>	
Hmotnost Gewicht Weight	325 kg	Rozměry topeniště (výška x šířka x hloubka) Maße Feuerraum (höhe x breite x tiefe) Combustion Chamber Dimensions (height x width x depth)	330 x 520 x 300 (mm)
		Hein & spol. - keramické závody, spol. s r. o. Odry - Tošovice	